

ADP5E... DIRECTIONAL CONTROL CETOP 5

HIGH PERFORMANCES SOLENOID OPERATED VALVES



ADP5E...

"D19" DC SOLENOIDS	CAP. I • 43
STANDARD CONNECTORS	CAP. I • 20

The NG10 directional control valves are designed for subplate mounting with an interface in accordance with UNI ISO 4401 - 05 - 04 - 0 - 94 standard (ex CETOP R 35 H 4.2-4-05). The use of solenoids with wet armatures allows an extremely safe construction completely dispensing with the need for dynamic seal. The solenoid tube is screwed directly onto the valve casing whilst the coil is kept in position by a ring nut. Great care has been taken over the design and production of the ducts and the improvement of the spools allows relatively high flow rates to be accommodated for its size with minimal pressure drops (Δp). The operation of the directional valve is electrical. The centring is achieved by means of calibrated length springs which, once the impulse is over, immediately reposition the spool in the neutral position. The solenoids, constructed with a protection class of IP66 in accordance with BS 5490 standards, are available in direct current form and different voltage. The electrical controls are equipped with an emergency manual control inserted in the tube.

The ADP5.E.. valve has certain design features which allow it to "manage" a hydraulic power equal to $Q = 120\text{l/min}$ with a $P = 320\text{ bar}$, maintaining a considerable safety margin. These features can be summarized as follows:

- Solenoid D19 with an optimum ratio between the power absorbed (42W) and the magnetic force
- Diameter of the spool 18 mm, with carefully designed geometry improved to compensate for the flow forces
- Compact graphite cast iron valve casing with high mechanical resistance
- Different springs, improved according to the features of the spool

The electrical supply connectors meet DIN 43650 ISO 4400 standards; connectors are also available with built in rectifiers or pilot lights.

The recommended fluids are hydraulic mineral based oils in accordance with DIN 51524 and it is recommended that filters should be fitted to ensure a maximum contamination level of class 10 in accordance with NAS 1638, $\beta_{25} \geq 75$.

For other fluids please contact our technical department.

• **The solenoids are in DC voltage only**

PRESSURE DROPS

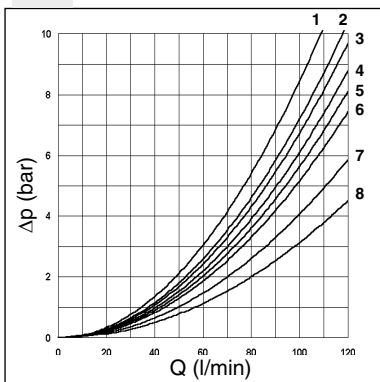

The diagram at the side shows the pressure drop curves for spools during normal usage. The fluid used is a mineral oil with a viscosity of $46\text{ mm}^2/\text{s}$ at 40°C ; the tests have been carried out at a fluid temperature of 40°C . For higher flow rates than those in the diagram, the losses will be those expressed by the following formula:

$$\Delta p_1 = \Delta p \times (Q_1/Q)^2$$

where Δp will be the value for the losses for a specific flow rate Q which can be obtained from the diagram, Δp_1 will be the value of the losses for the flow rate Q_1 that is used.

Spool type	Connections				
	P→A	P→B	A→T	B→T	P→T
01	4	4	7	7	
02	6	6	8	8	7
03	3	3	8	8	
04	4	4	2	2	3
05	6	6	6	6	
66	4	4	8	7	
06	4	4	7	8	
14	6	4	8	6	2
15-19	2	2	5	5	
16-20	1	1	2	2	
28	4	6	6	8	2

Curve No.

ORDERING CODE

ADP	High performances directional control valve
5	CETOP 5/NG10
E	Electrical operator
**	Spools (Table next page)
*	Mounting (table 1)
*	Voltage (table 2)
**	Variants (table 3)
1	Serial No.

TAB.3 - VARIANTS

VARIANT	CODE
No variant (without connectors)	S1(*)
Viton	SV(*)
Rotary emergency button	P2(*)
Adjustable spool movement speed control	4S(*)
With solenoid chamber external drainage (Y)	S5(*)
Spool movement speed control (VDC only) with $\varnothing 0.5\text{ mm}$ \varnothing orifice	5S(*)
Spool movement speed control VDC only) with $\varnothing 0.8\text{ mm}$ \varnothing orifice	8S(*)
Other variants available on request	

(*) Coils with Hirschmann connection supplied without connectors. The connectors can be ordered separately, c Cap. I • 20.

TAB.1 - MOUNTING

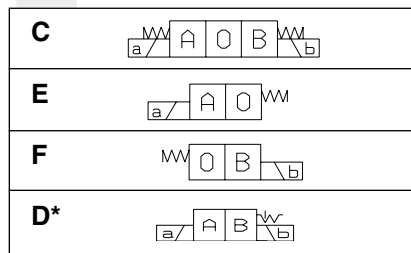

(*) Valve with detent

TAB.2 - TYPE E CONTROL

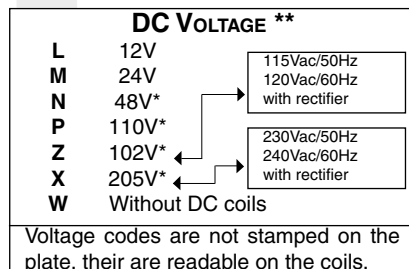

Voltage codes are not stamped on the plate, they are readable on the coils.

* Special voltage

** Technical data see Cap. I • 43

STANDARD SPOOLS

* SPOOLS WITH PRICE INCREASING

TWO SOLENOIDS, SPRING CENTRED "C MOUNTING"			
Spool type		Covering	Transient position
01		+	
02		-	
03		-	
04*		-	
05		-	
66		-	
06		-	
14*		-	
28*		-	

TWO SOLENOIDS "D MOUNTING"			
Spool type		Covering	Transient position
19*		-	
20*		+	

ONE SOLENOID, SIDE A "E MOUNTING"			
Spool type		Covering	Transient position
01		+	
02		-	
03		-	
04*		-	
05		-	
66		-	
06		-	
14*		-	
15		-	
16		+	
28*		-	

ONE SOLENOID, SIDE B "F MOUNTING"			
Spool type		Covering	Transient position
01		+	
02		-	
03		-	
04*		-	
05		-	
66		-	
06		-	
14*		-	
15		-	
16		+	
28*		-	

LIMITS OF USE (MOUNTING C-E-F)

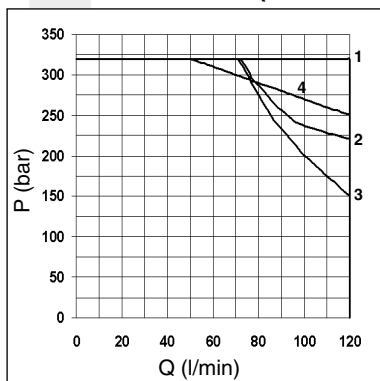

Spool type	n° curves
01	1
02	1
03	2
04	1
05	1
66	1
06	1
14	3
15	1
16	1
28	3
19	4
20	4

The tests have been carried out with solenoids at operating temperature and a voltage 10% less than rated voltage with a fluid temperature of 50°C.

The fluid used was a mineral oil with a viscosity of 46 mm²/s at 40°C.

The values in the diagram refer to tests carried out with the oil flow in two directions simultaneously (e.g. from P to A and at the same time B to T).

In the cases where valves 4/2 and 4/3 were used with the flow in one direction only, the limits of use could have variations which may even be negative.

The tests were carried out with a counter-pressure of 2 bar at T.

ADP5E... HIGH PERFORMANCES SOLENOID OPERATED VALVE CETOP 5

1

ADP5.E... 4S variant - These ON-OFF type valves are used when a lower spool movement speed is required than it is generally available with a conventional solenoid valve in order to avoid those shocks which might otherwise compromise proper system operation. This is obtained by forcing the fluid to pass through the gap which exists between the screw thread and the M8x1 tapped thread, restricting in this way the transfer cross section between the 2 solenoid chambers. Using this variant may entail a reduction in the operational limits according to the spool used, up to the complete blocking of the change over itself. The valve operation depends on the presence of a minimum back pressure on the T line (min. 1 bar). The change over time referred to the spool stroke depends on 4 main variables:

- Applicable hydraulic power, related to the flow rate and pressure drop across the valve;
- Spool type (system configuration);
- Oil viscosity and temperature;
- Back pressure on T.

Max. operating pressure: ports P/A/B	350 bar
Max. operating pressure: port T (*)	250 bar
Max. flow	120 l/min
Max. excitation frequency	3 Hz
Duty cycle	100% ED
Fluid viscosity	10 ÷ 500 mm ² /s
Fluid temperature	-25°C ÷ 75°C
Ambient temperature	-25°C ÷ 60°C
Max. contamination level	class 10 in accordance with NAS 1638 with filter β ₂₅ ≥ 75
Weight with one DC solenoid	5 Kg
Weight with two DC solenoids	6,5 Kg

(*) Pressure dynamic allowed for 2 millions of cycles

Pressure on port T valid in case Y is blocked (no external drainage). Normally the external drained is blocked with a plug S.T.E.I M6x6 UNI 5923

ADP5.E... S5 variant - These are valves with solenoid chambers drainage separated from the T line, obtained on CETOP RO5 interface and characterized by the letter Y. This solution allows operation with up to 320 bar max. back pressure on the T line while using only 12.9 material fixing screws to ensure maximum solenoid valve mounting safety and supplementary drainage.

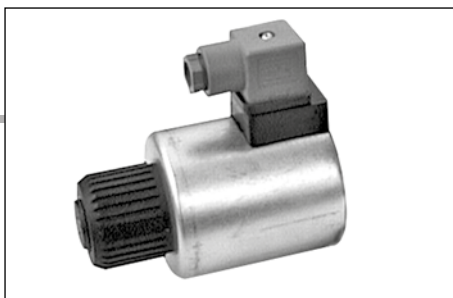
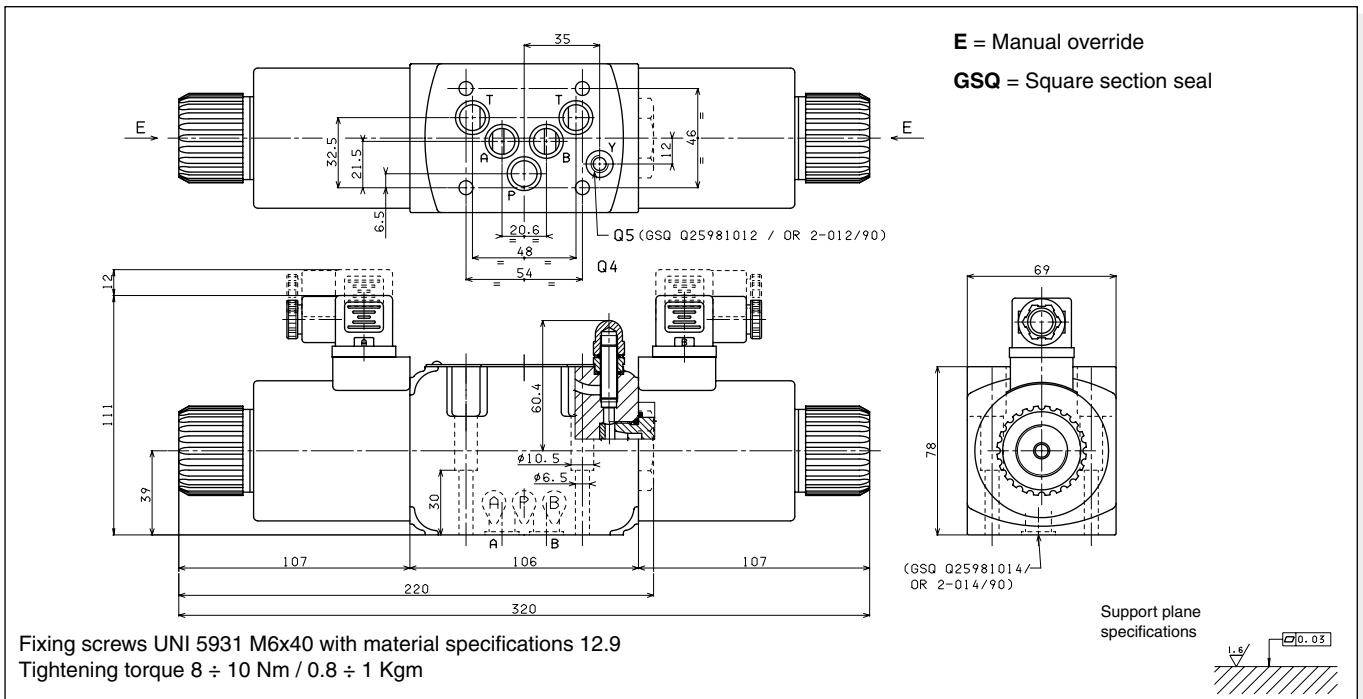

“D19” DC SOLENOIDS

Type of protection (in relation to the connector used)	IP 66
Number of cycle	18.000/h
Supply tolerance	±10%
Ambient temperature	-54°C ÷ 60°C
Duty cycle	100% ED
Max static pressure	210 bar
Insulation class wire	H
Weight	1,63 Kg

ROTARY EMERGENCY

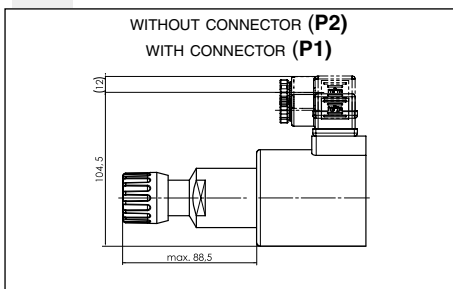

VOLTAGE (V)	MAX WINDING TEMPERATURE (AMBIENT TEMPERATURE 25°C)	RATED POWER (W)	RESISTANCE AT 20°C (OHM) ±10%
12V	105°C	42	3.43
24V	105°C	42	13.71
48V*	105°C	42	55
102V*(**)	105°C	42	248
110V*(**)	105°C	42	288
205V*(**)	105°C	42	1000

* Special voltage

** The european low voltage directive is applied to electrical equipments used at a nominal voltages between 50 and 1000 VAC or 75 and 1500 VDC. In conformity with the low directive each part of the manifold or the subplate on which the valve is mounted should be connected to a protective earth with a resistance less than 0.1 ohms.