

INLET MODULE UNITS WITH PRESSURE RELIEF VALVE AND ELECTRICAL VENTING VALVE

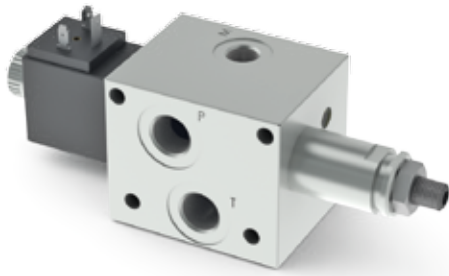

Connector to be ordered separately, see page 105.

HYDRAULIC SYMBOL

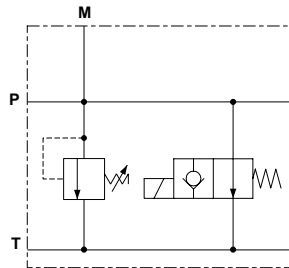

ORDERING CODE

FE10	Inlet module unit with pressure relief valve
P	Electric venting valve
3	Size
*	Port sizes: 1 = G3/8" 2 = 9/16"-18UNF
*	Adjustment: M = Plastic knob C = Grub screw
*	Setting ranges 1 = max. 50 bar (white spring) 2 = max. 150 bar (yellow spring) 3 = max. 320 bar** (green spring)
*	Voltage for the electric venting valve (Tab. 1)
**	S1 = No variants SV = Viton PY = Push button emergency (see page 22) PS = Rotary emergency (see page 22) AJ = AMP Junior connection (see page 106) CX = Deutsch connection with bidirectional diode (see page 106)
2	Serial No.

(**) Setting referred to the maximum pressure reached from the relief valve. Do not exceed the maximum working pressure 250 bar.

Module units FE10P with CMP10 adjustable pressure relief valve and electrical venting valve CRP0418NA normally open supplied with emergency control.

- Manual adjustment with a grub screw or plastic knob.
- Threaded ports P-T sizes G3/8" or 9/16"-18UNF.
- Pressure gauge M, G1/4"
- Maximum flow 40 l/min.
- Aluminum body.

FEATURES

Max. operating pressure	250 bar
Max. Flow	40 l/min
Hydraulic fluid	DIN 51524 Mineral oils
Fluid viscosity	10 ÷ 500 mm ² /s
Fluid temperature	-25°C ÷ 75°C
Ambient temperature	-25°C ÷ 60°C
Max. contamination level (filter β ₂₅ ≥ 75)	ISO 4406:1999: class 21/19/16 NAS 1638: class 10
Weight	1.1 kg

Pressure relief valve (CMP10...)

Setting range (*):	
Spring 1	max 50 bar
Spring 2	max 150 bar
Spring 3	max 320 bar

Electrical venting valve (CRP04..NA..)

Max. excitation frequency	2 Hz
Duty cycle	100% ED
Type of protection (in relation to the connector used)	IP65

(*) The minimum permissible setting pressure depending on the spring: see curves.

Tab.1 - Voltage - Coil 18W/22W (1)

L	12 VDC
M	24 VDC
N	48 VDC
2	21.6 VDC
Z (2)	102 VDC RAC
X (3)	205 VDC RAC
W (4)	Without coil

(1) Connector to be ordered separately, see page 105;
Coils technical data, see page 106;

(2) With rectifier: 115 VAC/50Hz - 120 VAC/60Hz

(3) With rectifier: 230 VAC/50Hz - 240 VAC/60Hz

(4) Performance are guaranteed only using valves completed with coil

DIAGRAMS - PRESSURE RELIEF VALVE

PRESSURE-FLOW RATE

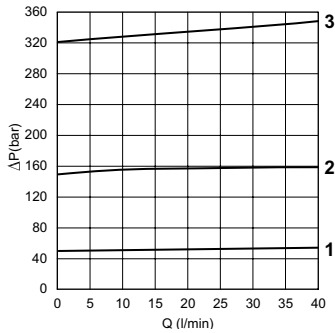

MIN.SETTING PRESSURE

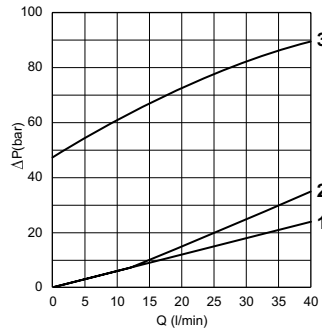

- 1 = max 50 bar
- 2 = max 150 bar
- 3 = max 320 bar

Fluid used: mineral based oil with viscosity 46 mm²/s at 40°C.

DIAGRAMS - ELECTRICAL VENTING VALVE

PRESSURE DROPS

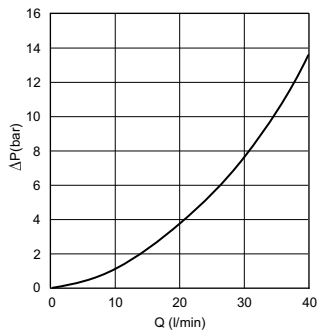

LIMITS OF USE

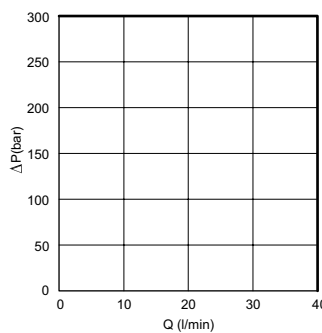

Fluid used: mineral based oil with viscosity 46 mm²/s at 40°C.

OVERALL DIMENSIONS

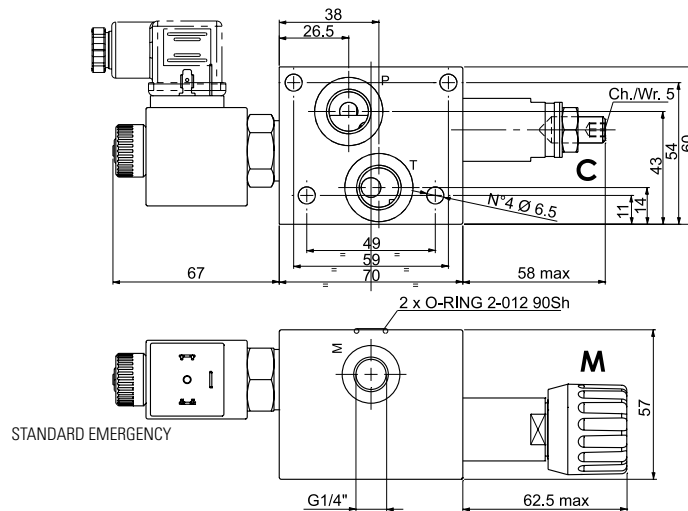

- C = Grub screw
- M = Plastic knob

VARIANTS

"PS"
Emergency rotary

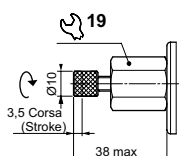

"PY"
Emergency with push button

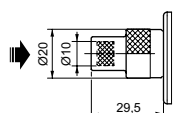

"AJ"
AMP Junior

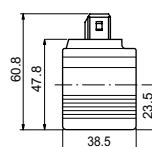

"CX"
Deutsch with diode

